

mitsubishi electric

Mr. SLIM

Air-Conditioners

PLH18, 24, 30, 36, 42AK

PL12, 18, 24, 30, 36, 42AK

PCH24, 30, 36, 42GK

PC24, 30, 36, 42GK

PKH18, 24, 30, 36FK3

PK12, 18, 24, 30, 36FK3

PKH18, 24, 30, 36FL

PK18, 24, 30, 36FL3

FOR USER

OPERATION MANUAL

For safe and correct use, please read this operation manual thoroughly before operating the air-conditioner unit.

 **MITSUBISHI
ELECTRIC**

Contents

1. Safety Precautions	2
2. Operation	3
2.1. Switching the unit on/off	3
2.2. Mode select	3
2.3. Selecting a temperature	3
2.4. Selecting a fan speed	3
2.5. Adjusting airflow direction	4
2.6. Using the timer	4
3. Care and cleaning	5
3.1. Cleaning the filters and the indoor unit	5
3.2. Care and cleaning	6
4. Troubleshooting	6
5. Specifications	7

1. Safety Precautions

- ▶ Before installing the unit, make sure you read all the “Safety precautions”.
- ▶ The “Safety precautions” provide very important points regarding safety. Make sure you follow them.
- ▶ If none of the above apply, turn the main switch off and contact the dealer from whom you bought the air-conditioner, telling him the model name and the nature of the problem.
Do not try to fix the unit yourself.

Symbols used in the text

⚠ Warning:

Describes precautions that should be observed to prevent danger of injury or death to the user.

⚠ Caution:

Describes precautions that should be observed to prevent damage to the unit.

Symbols used in the illustrations

⊘ : Indicates an action that must be avoided.

❗ : Indicates that important instructions must be followed.

⚡ : Indicates a part which must be grounded.

⚠ Warning:

Carefully read the labels affixed to the main unit.

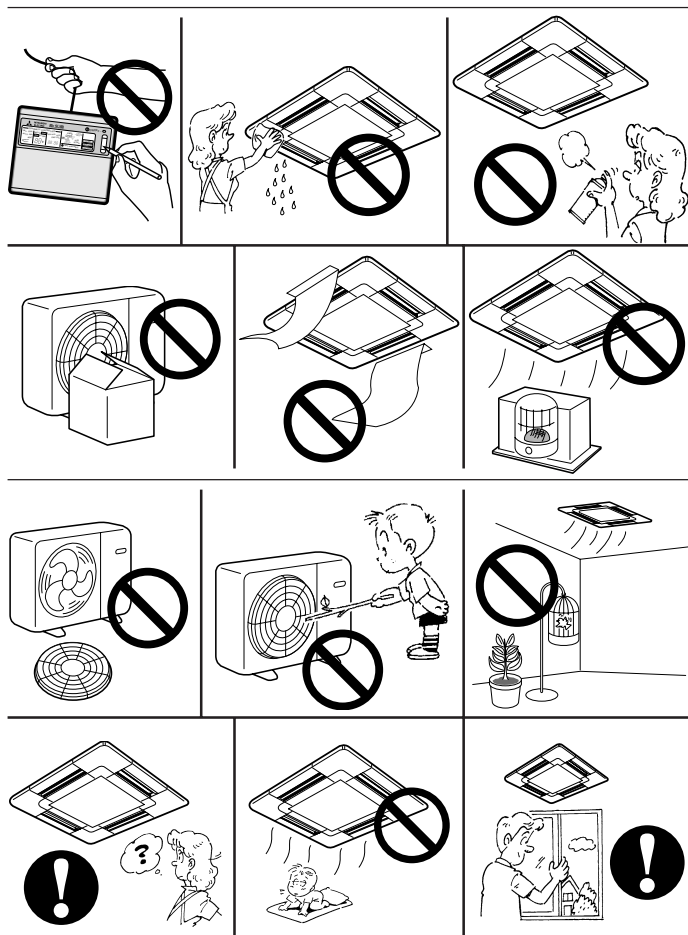

⚠ Warning:

- The unit should not be installed by the user. Ask the dealer or an authorized company to install the unit. If the unit is installed improperly, water leakage, electric shock or fire may result.
- Do not stand on, or place any items on the unit.
- Do not splash water over the unit and do not touch the unit with wet hands. An electric shock may result.
- Do not spray combustible gas close to the unit. Fire may result.
- Do not place a gas heater or any other open-flame appliance where it will be exposed to the air discharged from the unit. Incomplete combustion may result.

⚠ Caution:

- Do not use any sharp object to push the buttons, as this may damage the remote controller.
- Never block or cover the indoor or outdoor unit's intakes or outlets.

⚠ Warning:

- Do not remove the front panel or the fan guard from the outdoor unit when it is running. You could be injured if you touch rotating, hot or high-voltage parts.
- Never insert fingers, sticks etc. into the intakes or outlets, otherwise injury may result, since the fan inside the unit rotates at high speed.
- If you detect odd smells, stop using the unit, turn off the power switch and consult your dealer.
- This air conditioner is NOT intended for use by children or infirm persons without supervisions.
- Young children should be supervised to ensure that they do not play with the air conditioner.

Disposing of the unit

When you need to dispose of the unit, consult your dealer. If pipes are removed incorrectly, refrigerant (fluorocarbon gas) may blow out and come into contact with your skin, causing injury. Releasing refrigerant into the atmosphere also damages the environment.

2. Operation

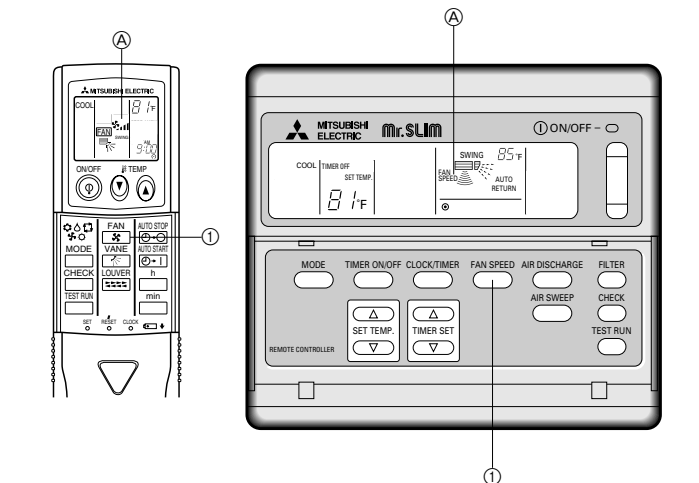
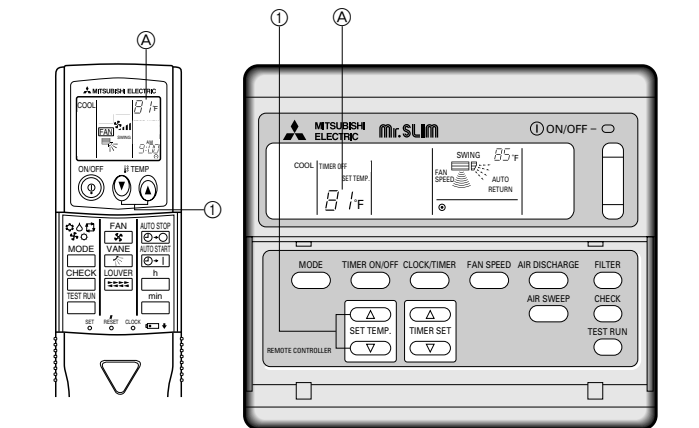
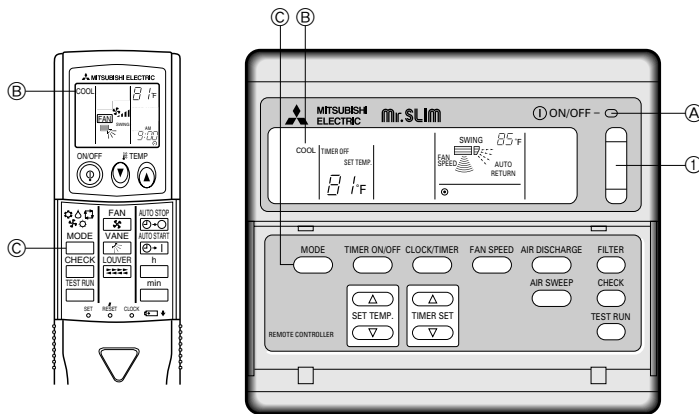
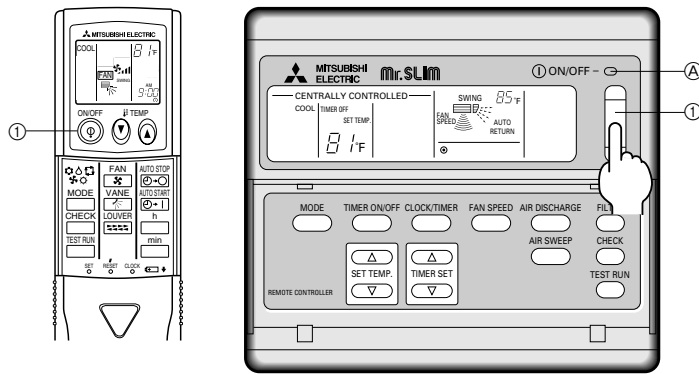

Operating range

		Indoor air intake temperature	Outdoor air intake temperature
Cooling	Maximum	95 °F DB, 71 °F WB	115 °F DB
	Minimum	67 °F DB, 57 °F WB	0 °F DB*
Heating	Maximum	80 °F DB, 67 °F WB	75 °F DB, 65 °F WB
	Minimum	70 °F DB, 60 °F WB	17 °F DB, 15 °F WB

* With wind baffle installed. Without wind baffle, the minimum temperature will be 23 °F DB.

2.1. Switching the unit on/off

• The power supply should not be turned off while the air conditioner is in use. This can cause the unit to break down.

① Press the ON/OFF button.

Ⓐ The ON indicator should light up.

• Even if you press the ON/OFF button immediately after shutting down the operation in progress, the air conditioner will not start for about three minutes. This is to prevent the internal components from being damaged.

• If the operation stops due to a power failure, the unit will not automatically restart until the power has been restored. Press the ON/OFF button to restart.

2.2. Mode select

① If the unit is off, press the ON/OFF button to turn it on.

Ⓐ The ON indicator should light up.

② Press the operation mode button ③ and select the operation mode.

Ⓑ

COOL	Cooling mode	AUTO	Automatic (cooling/heating) mode (For PLH/PCH/PKH)
DRY	Drying mode	HEAT	Heating mode (For PLH/PCH/PKH)
FAN	Fan mode (For PL/PC/PK)		

Note:

The heating display and the automatic display does not appear in models that operate exclusively as cooling only air-conditioner.

2.3. Selecting a temperature

▶ To decrease the room temperature:

① Press set temperature button to set the desired temperature.

Ⓐ The selected temperature is displayed.

• Each time you press the button, the temperature value decreases by 2 °F.

▶ To increase the room temperature:

① Press set temperature button to set the desired temperature.

Ⓐ The selected temperature is displayed.

• Each time you press the button, the temperature value increases by 2 °F.

• Available temperature ranges are as follows:

Cooling & Drying:	65 - 87 °F
Heating:	61 - 83 °F
Automatic:	65 - 83 °F

• The display flashes either 47 °F or 97 °F to inform you if the room temperature is lower or higher than the displayed temperature.

2.4. Selecting a fan speed

① Press fan speed button to select a desired fan speed.

• Each time you press the button, available options change with the display ② on the remote controller, as shown below.

	Wireless type	Wired type
Display	FAN - FAN	FAN SPEED - FAN SPEED
Available Option (Fan Speed Switch)	Low-High	Low-High

The display and the fan speed of the unit will differ in the following situations:

- When STAND BY and DEFROST are displayed.
- Just after the heating mode (while waiting to change to another mode).
- When the temperature of the room is higher than the temperature setting of the unit operating in the heating mode.
- In Dry mode, where the speed is set automatically and cannot be changed. Only the display on the remote controller changes.

2. Operation

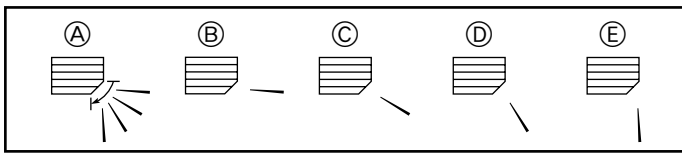

	A	B	C	D	E
PL(H)	Swing	30°	45°	55°	70°
PK(H)*	Swing	10°	30°	60°	70°
PK12FK3	—	10°	30°	60°	70°
PC(H)	Swing	100% Horizontal	20°	40°	60°

* Except PK12FK3

2.5. Adjusting airflow direction

The vertical air vane helps select the vertical direction of the airflow.

① Press AIR DISCHARGE button to select the vertical airflow direction.

- Each time you press the button, the option changes are displayed on the remote controller, as shown below.

(A (swing) → B → C → D → E → A)

- In cooling/drying mode with the fan speed set to LOW, every press on the button will change the direction in the order of A, B, D, A. (C can not be set)
- If D or E is set, the angle will automatically revert to B after one hour of operation. (Do not use D and E too often in cooling/drying mode with the fan speed set to LOW, or condensation or dripping can occur.)
- E "AUTO RETURN" should be displayed.

- When the angle setting is C in cooling mode, switching the fan speed from HIGH to LOW will cause the angle to revert to B automatically.
- The airflow direction can not be set with UP/DOWN while the SWING setting is being used.
- The arrow indicators are alternately displayed when the air sweep is in operation, however they are not displayed when the air sweep is not in operation.
- The left/right guide vanes of PC(H) series and the guide vane of the PK(H) series can be changed manually.

2.6. Using the timer

1) Set the current time

① Press clock/timer button to display the "CLOCK" B.

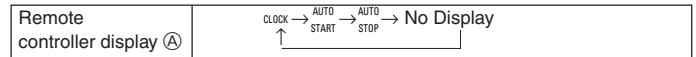

- ② Each time you press button, the time increases in increments of one minute. Each time you press button, the time decreases in increments of one minute.
- Press and hold the button to rapidly change the time.
 - The time changes in increments of one minute → ten minutes → in units of hour; in this order.
 - Approximately ten seconds after pressing the button, the display on the remote controller will turn off.

(For Wireless Remote Controller)

- Press the CLOCK button using a thin stick and blink the time A.
- Press the and button to set the current time.
- Press the CLOCK button using a thin stick.

2) Set the time to start the unit as follows

- Press clock/timer button to display B .
- Press button to set the time that you want the unit to start.

The start time is displayed at A.

(For Wireless Remote Controller)

- Press the button.
- Time can be set while the following symbol is blinking.
ON time : B START is blinking.
- Use the and buttons to set the desired time.
- To cancel the ON timer, press the button.

3) Set the time to stop the unit as follows

- Press clock/timer button to display C .
- Press button to set the time that you want the unit to stop.

The stop time is displayed at A.

(For Wireless Remote Controller)

- Press the button.
- Time can be set while the following symbol is blinking.
OFF time : C STOP is blinking.
- Use the and buttons to set the desired time.
- To cancel the OFF timer, press the button.

4) Changing the set times

- Press clock/timer button to display the time (CURRENT, START, STOP) you want to change.
- Press button to set the desired time.

- When change is made to either one of a pair, e.g., AUTO START or AUTO STOP, set the time you need not to change to . This display is available following 23:50.

(For Wireless Remote Controller)

Press the or to cancel the timer and repeat from 2) or 3).

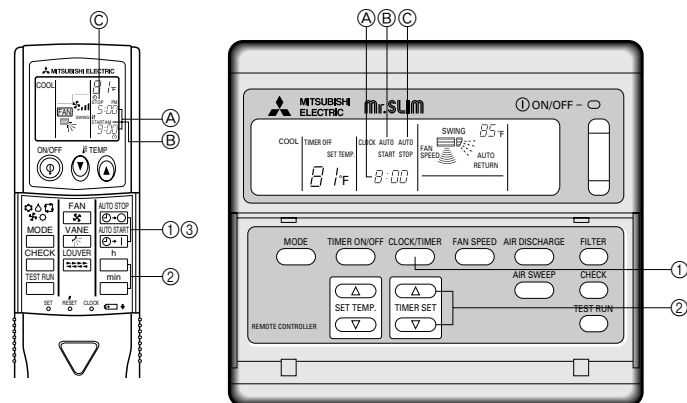
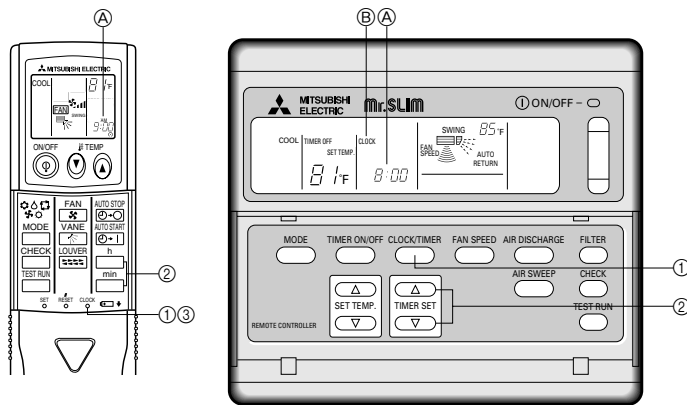
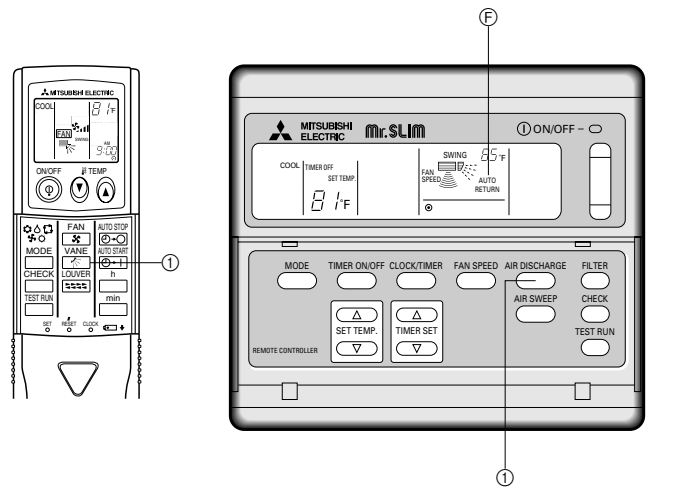

3. Care and cleaning

■ PLH/PL Series

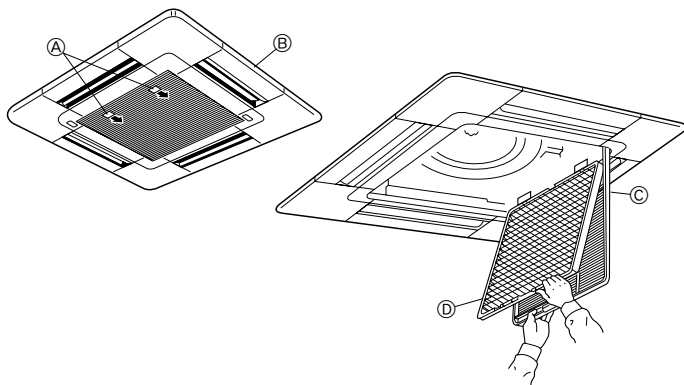

■ PCH/PC Series

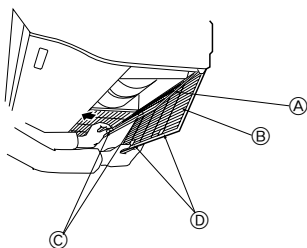

■ PKH/PK Series

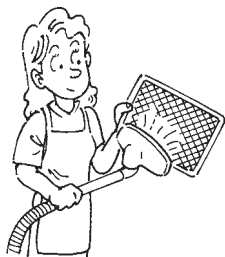
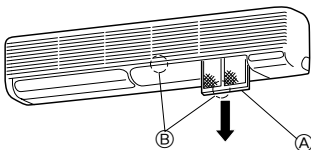

⚠ Caution:

- Always turn off the power, first on the remote controller and then the main switch, before cleaning or servicing the unit.
- When installing or removing the filter or the intake grille, do not stand on an unsteady surface. You may fall and injure yourself. Be also careful not to let dust fall into your eyes.

Dirty or clogged filters block the airflow and reduce efficiency. Very dirty filters can damage the air-conditioner itself.

■ PLH/PL Series

Intake grille removal

- Pull the knob on the intake grille in the direction indicated by the arrow and it should open.
- Unhook the hinges to remove the intake grille from the grille.

Filter removal

- Open the intake grille.
- Release the knob on the center edge of the intake grille and pull the filter forward to remove the filter.

Ⓐ Knob Ⓑ Grille Ⓒ Intake grille Ⓓ Filter

■ PCH/PC Series

- Open the intake grille.
- Hold the knob on the filter then pull the filter up in the direction of an arrow. To replace the filter after cleaning, be sure to insert the filter far enough until it fits into the stopper.

Ⓐ Filter Ⓑ Intake Grille Ⓒ Knob Ⓓ Stopper

■ PKH/PK Series

- Hold the filter lug (located at the bottom of the intake grill) and pull it out downward.
- To install the filters, push the filter lug upward.

Ⓐ Filter Ⓑ Lug

3.1. Cleaning the filters and the indoor unit

Cleaning the filters

- Clean the filters using a vacuum cleaner. If you do not have a vacuum cleaner, tap the filters against a solid object to knock off dirt and dust.
- If the filters are especially dirty, wash them in lukewarm water. Take care to rinse off any detergent thoroughly and allow the filters to dry completely before putting them back into the unit.

⚠ Caution:

- Do not dry the filters in direct sunlight or by using a heat source, such as an electric heater: this may warp them.
- Do not wash the filters in hot water (above 120°F), as this may warp them.
- Make sure that the air filters are always installed. Operating the unit without air filters can cause malfunction.

Cleaning the indoor unit

- Wipe the outside of the unit with a clean, dry, soft cloth.
- Clean off any oil stains or finger marks using a neutral household detergent (such as dishwashing liquid or laundry detergent).

⚠ Caution:

Never use gasoline, benzene, thinner, scouring powder or any type of non-neutral detergent, as these substances may damage the unit's case.

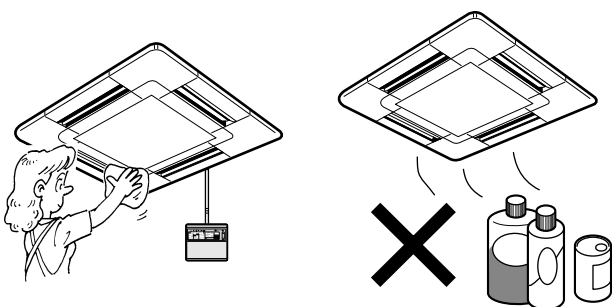

3. Care and cleaning

4. Troubleshooting

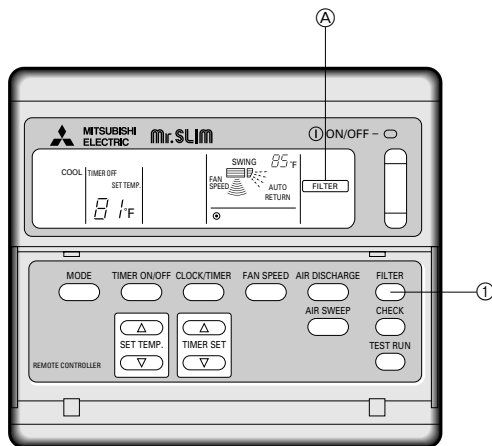

3.2. Care and cleaning

Clean the filter

When the (A) "FILTER" indicator blinks on the remote controller to alert you to the necessity of cleaning of the filter.

* As a guideline for typical office environment, the long-life filter must be cleaned every 2,500 (PL(H))/100 (PC(H), PK(H)) operating hours.

Reset the FILTER indicator

① Press the FILTER button twice after cleaning.

▶ When you press the FILTER button twice, the "FILTER" indicator (A) will be turned off and reset.

▶ The FILTER indicator provides you with a guideline for the necessity of filter cleaning based on total operating hours in typical indoor air conditions. Depending on different operating environments, more or less frequent cleaning may be necessary.

• Not available for wireless remote controller.

4. Troubleshooting

Before you call out a repair man, check the following table to see whether there is a simple solution to your problem.

Problem	Display reading	Cause	Solution
Unit will not start.	Pilot lamp does not turn on even when the POWER ON/OFF button is pressed.	Main power switch is turned off.	Turn main power on. Then press the POWER ON/OFF button to turn the unit on.
		Main power fuse has blown.	Replace the fuse.
		Outdoor unit's ground fault breaker is open.	Reset the ground fault breaker.
		A power cut has occurred (see NOTE below).	Wait until power is restored, then press the POWER ON/OFF button to turn the unit on.
Unit discharges air well, but fails to cool or heat the room well.	Remote controller shows that the unit is operating.	Improper temperature setting - e.g. you have selected COOL mode, but the desired temperature setting is higher than the current room temperature.	Check the set temperature on the remote controller and the actual intake air temperature. Use the COOLER and WARMER buttons to set the temperature as described in "Selecting a temperature" on page 3.
		Filters are clogged.	Clean the filter and resume operation. See "Cleaning the filters and the indoor unit" on page 5.
		Outdoor unit's intake or outlet is obstructed.	Remove the obstruction.
		A door or window has been left open.	Shut door or window.
Unit does not start immediately.	Remote controller shows that the unit is operating.	Unit is waiting three minutes before restarting.	Wait until the unit restarts automatically. The compressor may hesitate resuming because a three-minute resume prevention circuit is incorporated in the outdoor unit for protection of the compressor.
Unit stops soon after starting.	Remote controller check display reads "CHECK P6" or "CHECK P8".	Indoor or outdoor unit's intake or outlet is obstructed.	Remove obstruction and restart the unit.
		Filters are clogged.	Remove the obstruction. Clean the filter and resume operation.

NOTE: After a power cut, the unit will not restart automatically. You will have to restart it by pressing the POWER - ON/OFF button on the remote controller.

Wired remote controllers

In any of the following cases, turn off the main power switch and contact your local dealer for service:

- "CHECK" followed by "P1", "P2", "P3", "P4", "P5", "P7" or "CENTRALLY CONTROLLED" is displayed on the control panel.
- The switches do not work properly.
- The circuit breaker trips frequently (or the fuse blows frequently).
- Water has accidentally been splashed into the unit.
- Water leaks from the unit.
- Something is accidentally dropped into the air-conditioner.
- An unusual noise is heard during operation.

⚠ Warning:

If the air conditioner operates but does not cool or heat (depending on model) the room, consult your dealer since there may be a refrigerant leak.

Be sure to ask the service representative whether there is refrigerant leakage or not when repairs are carried out.

The refrigerant charged in the air conditioner is safe. Refrigerant normally does not leak, however, if refrigerant gas leaks indoors, and comes into contact with the fire of a fan heater, space heater, stove, etc., harmful substances will be generated.

5. Specifications

Item		Models	PLH18AK	PLH24AK	PLH30AK	PLH36AK	PLH42AK
Capacity	Cooling *1 BTU/h		18,000	24,000	30,000	35,400	42,000
	Heating *1,*3 BTU/h		19,000 [24,500/25,500]	26,000 [31,500/32,500]	33,000 [39,500/41,200]	38,000 [45,900/47,600]	44,300 [52,200/53,900]
	Heating *2,*3 BTU/h		11,000 [16,500/17,500]	16,500 [22,000/23,000]	18,500 [25,000/26,700]	23,000 [30,900/32,600]	26,800 [34,700/36,400]
Power consumption	Cooling *1 kW		1.75	2.57	3.17	3.63	3.98
	Heating *1,*3 kW		1.59 [3.19/3.49]	2.51 [4.11/4.41]	3.04 [4.94/5.44]	3.45 [5.75/6.25]	3.82 [6.12/6.62]
	Heating *2,*3 kW		1.32 [2.92/3.22]	2.15 [3.75/4.05]	2.55 [4.45/4.95]	2.93 [5.23/5.73]	3.24 [5.54/6.04]
SEER		10.5	10.3	10.4	10.0	10.7	
HSPF		7.2	7.0	6.9	7.1	7.0	
INDOOR UNIT MODELS			PLH18AK	PLH24AK	PLH30AK	PLH36AK	PLH42AK
External finish			Munsell 0.7Y 8.59/0.97				
Power supply V, Phase, Hz			208/230, 1, 60				
Max. fuse size (time delay) A			20		25		
Min. ampacity A			15		17		
Fan motor F. L. A.			0.7	1.2	1.4		
Auxiliary heater A (kW)			7.7/8.3 [1.6/1.9]		9.1/10.4 [1.9/2.4]	11.1/12.2 [2.3/2.8]	
Airflow	Dry	CFM	530-710	710-990	780-1060		
	Lo-Hi	Wet	CFM	490-670	670-950	740-1020	
Dimensions	W	in	33-1/16				
	D	in	33-1/16				
	H	in	10-3/16	11-3/4			
Dimensions (GRILLE)	W	in	37-3/8				
	D	in	37-3/8				
	H	in	1-3/16				
Weight	lbs	57	71	75	75		
Weight (GRILLE) lbs			11				
OUTDOOR UNIT MODELS			PUH18EK	PUH24EK	PUH30EK	PUH36EK	PUH42EK7
External finish			Munsell 5Y 7/1				
Power supply V, Phase, Hz			208/230, 1, 60				
Max. fuse size (time delay) A			20		30	40	
Min. ampacity A			16		20	22	28
Fan motor F. L. A.			0.75	0.65+0.65	0.75+0.75		0.8+0.8
Compressor	Models		RH247NAB	NH33NBD	NH41NAD	NH47NAD	ZR42K3-PFV
	R. L. A.		12.0	11.5	14.0	17.5	20.4
	L. R. A.		37	54	73	87	109
Crankcase heater A (W)			0.11/0.17 (23/28)		0.16/0.17 (33/39)		
Refrigerant control			Capillary tube				
Defrost method			Reverse cycle				
Dimensions	W	in	34-1/4		38-3/16		
	D	in	11-5/8		13-9/16		
	H	in	33-1/2	49-9/16			
Weight	lbs	131	202	245	246	246	
REMOTE CONTROLLER			With grille				
Control voltage (by built-in transformer)			Indoor unit-remote controller DC12V, Indoor unit- outdoor unit DC12V				

NOTES: *1 Rating conditions (cooling) – indoor: 80°F DB. 67°F WB outdoor: 95°F DB. 75°F WB
 (heating) – indoor: 70°F DB. 60°F WB outdoor: 47°F DB. 43°F WB
 *2 Rating conditions (heating) – indoor: 70°F DB. 60°F WB outdoor: 17°F DB. 15°F WB
 *3 Heating capacity and power consumption in [] include auxiliary electric heater operation at 208/230V.

Units should be installed by licensed electric contractor accordingly to local code requirement.

* Specifications subject to change without notice.

5. Specifications

Item	Models	PL12AK	PL18AK	PL24AK	PL30AK	PL36AK	PL42AK
Cooling capacity	*1 BTU/h	12,500	18,400	24,000	31,000	36,500	42,500
Power consumption	*1 kW	1.26	1.85	2.65	3.17	3.64	4.08
SEER		10.1	10.2	10.0	10.6	10.5	10.8
INDOOR UNIT MODELS		PL12AK	PL18AK	PL24AK	PL30AK	PL36AK	PL42AK
External finish		Galvanized sheets with gray heat insulation					
External finish (GRILLE)		Munsell 0.7Y 8.59/0.97					
Power supply	V, Phase, Hz	115, 1, 60					
Max. fuse size (time delay)	A	15					
Min. ampacity	A	2.0			3.0		
Fan motor	F. L. A.	1.2			2.6		
Airflow	Dry CFM	420-560	530-710	710-990	780-1060		
Lo-Hi	Wet CFM	390-530	490-670	670-950	740-1020		
Dimensions	W	in 33-1/16					
	D	in 33-1/16					
	H	in 10-3/16			in 11-3/4		
Dimensions (GRILLE)	W	in 37-3/8					
	D	in 37-3/8					
	H	in 1-3/16					
Weight	lbs	49	53	66	71		
Weight (GRILLE)	lbs	11					
OUTDOOR UNIT MODELS		PU12EK	PU18EK	PU24EK	PU30EK	PU36EK	PU42EK7
External finish		Munsell 5Y 7/1					
Power supply	V, Phase, Hz	208/230, 1, 60					
Max. fuse size (time delay)	A	15	20		30		40
Min. ampacity	A	11	16		20	22	28
Fan motor	F. L. A.	0.65	0.75	0.65+0.65		0.75+0.75	0.8+0.8
Compressor	Model	RH167NAB	RH247NAB	NH33NBD	NH41NAD	NH47NAD	ZR42K3-PFV
	R. L. A.	8.9	12.0	11.5	14.0	17.5	20.4
	L. R. A.	29	37	54	73	87	109
Crankcase heater	A (W)	0.11/0.12 (23/28)			0.16/0.17 (33/39)		
Refrigerant control		Capillary tube					
Dimensions	W	in 34-1/4				in 38-3/16	
	D	in 11-5/8				in 13-9/16	
	H	in 25-9/16	in 33-1/2	in 49-9/16			
Weight	lbs	105	154	207		220	220
REMOTE CONTROLLER		With grille					
Control voltage	(by built-in transformer)	Indoor unit-remote controller DC12V, Indoor unit- outdoor unit DC12V					

NOTES: *1 Rating conditions (cooling) – indoor: 80°F DB. 67°F WB outdoor: 95°F DB. 75°F WB

Units should be installed by licensed electric contractor accordingly to local code requirement.

* Specifications subject to change without notice.

5. Specifications

Item		Models	PCH24GK	PCH30GK	PCH36GK	PCH42GK
Capacity	Cooling *1 BTU/h		24,000	30,000	35,400	42,000
	Heating *1,*3 BTU/h		27,000 [34,000/35,500]	33,000 [40,500/42,500]	38,000 [45,500/47,500]	45,000 [52,500/54,500]
	Heating *2,*3 BTU/h		14,800 [21,800/23,300]	20,000 [27,500/29,500]	21,000 [28,500/30,500]	23,800 [31,300/33,200]
Power consumption	Cooling *1 kW		2.51	3.23	3.60	4.10
	Heating *1,*3 kW		2.46 [4.49/4.94]	3.00 [5.25/5.76]	3.32 [5.57/6.08]	3.76 [6.03/6.52]
	Heating *2,*3 kW		1.95 [3.98/4.43]	2.58 [4.83/5.34]	2.63 [4.88/5.39]	3.00 [5.25/5.76]
SEER		10.3	10.0	10.3	10.3	
HSPF		6.8	7.0	7.0	7.2	
INDOOR UNIT MODELS			PCH24GK	PCH30GK	PCH36GK	PCH42GK
External finish			Munsell 0.7Y 8.59 / 0.97			
Power supply V, Phase, Hz			208 / 230, 1, 60			
Max. fuse size (time delay) A			20		25	
Min. ampacity A			15		17	
Fan motor F. L. A.			1.1		1.3	
Auxiliary heater A (kW)			9.8/10.8 [2.0/2.5]		10.8/12.0 [2.2/2.8]	
Airflow	Dry	CFM	710-880		990-1,240	
	Lo-Hi	Wet	CFM	640-810		880-1,130
Dimensions	W	in	51-9/16		63-3/4	
	D	in		26-3/4		
	H	in		10-5/8		
Weight lbs			87	101	106	
OUTDOOR UNIT MODELS			PUH24EK	PUH30EK	PUH36EK	PUH42EK7
External finish			Munsell 5Y 7/1			
Power supply V, Phase, Hz			208/230, 1, 60			
Max. fuse size (time delay) A			20	30		40
Min. ampacity A			16	20	22	28
Fan motor F. L. A.			0.65+0.65	0.75+0.75		0.8+0.8
Compressor	Models		NH33NBD	NH41NAD	NH47NAD	ZR42K3-PFV
	R. L. A.		11.5	14.0	17.5	20.4
	L. R. A.		54	73	87	109
Crankcase heater A (W)			0.16/0.17 (33/39)			
Refrigerant control			Capillary tube			
Defrost method			Reverse cycle			
Dimensions	W	in	34-1/4		38-3/16	
	D	in	11-5/8		13-9/16	
	H	in		49-9/16		
Weight lbs			202	245	246	246
REMOTE CONTROLLER			With indoor unit			
Control voltage (by built-in transformer)			Indoor unit-remote controller DC12V, Indoor unit- outdoor unit DC12V			

NOTES: *1 Rating conditions (cooling) – indoor: 80°F DB. 67°F WB outdoor: 95°F DB. 75°F WB
 (heating) – indoor: 70°F DB. 60°F WB outdoor: 47°F DB. 43°F WB
 *2 Rating conditions (heating) – indoor: 70°F DB. 60°F WB outdoor: 17°F DB. 15°F WB
 *3 Heating capacity and power consumption in [] include auxiliary electric heater operation at 208/230V.

Units should be installed by licensed electric contractor accordingly to local code requirement.

* Specifications subject to change without notice.

5. Specifications

Item	Models	PC24GK	PC30GK	PC36GK	PC42GK
Cooling capacity	*1 BTU/h	25,000	31,000	36,500	42,500
Power consumption	*1 kW	2.61	3.18	3.62	4.10
SEER		10.4	10.0	10.3	10.8
INDOOR UNIT MODELS		PC24GK	PC30GK	PC36GK	PC42GK
External finish		Munsell 0.7Y 8.59 / 0.97			
Power supply	V, Phase, Hz	115, 1, 60			
Max. fuse size (time delay)	A	15			
Min. ampacity	A	2.0		3.0	
Fan motor	F. L. A.	1.9		2.4	
Airflow	Dry CFM	710-880		990-1,240	
Lo-Hi	Wet CFM	640-810		880-1,130	
Dimensions	W	in	51-9/16		63-3/4
	D	in	26-3/4		
	H	in	10-5/8		
Weight	lbs	82	95	99	
OUTDOOR UNIT MODELS		PU24EK	PU30EK	PU36EK	PU42EK7
External finish		Munsell 5Y 7/1			
Power supply	V, Phase, Hz	208/230, 1, 60			
Max. fuse size (time delay)	A	20	30		40
Min. ampacity	A	16	20	22	28
Fan motor	F. L. A.	0.65+0.65		0.75+0.75	0.8+0.8
Compressor	Model	NH33NBD	NH41NAD	NH47NAD	ZR42K3-PFV
	R. L. A.	11.5	14.0	17.5	20.4
	L. R. A.	54	73	87	109
Crankcase heater	A (W)	0.16/0.17 (33/39)			
Refrigerant control		Capillary tube			
Dimensions	W	in	34-1/4		38-3/16
	D	in	11-5/8		13-9/16
	H	in	49-9/16		
Weight	lbs	207	208	220	220
REMOTE CONTROLLER		With indoor unit			
Control voltage (by built-in transformer)		Indoor unit-remote controller DC12V, Indoor unit- outdoor unit DC12V			

NOTES: *1 Rating conditions (cooling) – indoor: 80°F DB. 67°F WB outdoor: 95°F DB. 75°F WB

Units should be installed by licensed electric contractor accordingly to local code requirement.

* Specifications subject to change without notice.

5. Specifications

Item		Models	PKH18FK3/PKH18FL	PKH24FK3/PKH24FL	PKH30FK3/PKH30FL	PKH36FK3/PKH36FL
Capacity	Cooling *1 BTU/h		18,000	24,000	30,000	34,200
	Heating *1,*3 BTU/h		18,600 [24,100/25,100]	25,000 [30,500/31,500]	33,000 [39,100/40,500]	38,000 [44,100/45,500]
	Heating *2,*3 BTU/h		10,700 [16,200/17,200]	14,700 [20,200/21,200]	19,000 [25,100/26,500]	19,600 [25,700/27,100]
Power consumption	Cooling *1 kW		1.79	2.36	3.12	3.44
	Heating *1,*3 kW		1.56 [3.16/3.46]	2.37 [3.97/4.27]	3.02 [4.82/5.22]	3.54 [5.34/5.74]
	Heating *2,*3 kW		1.34 [2.94/3.24]	1.92 [3.52/3.82]	2.48 [4.28/4.68]	2.65 [4.45/4.85]
SEER		11.1	10.2	10.6	10.5	
HSPF		7.2	6.8	7.1	6.9	
INDOOR UNIT MODELS			PKH18FK3/PKH18FL	PKH24FK3/PKH24FL	PKH30FK3/PKH30FL	PKH36FK3/PKH36FL
External finish			Munsell 3.4Y 7.7/0.8			
Power supply V, Phase, Hz			208/230, 1, 60			
Max. fuse size (time delay) A			15			
Min. ampacity A			12			13
Fan motor F. L. A.			0.5			0.6
Auxiliary heater A (kW)			7.6/8.4 [1.6/1.9]		8.7/9.6 [1.8/2.2]	
Airflow	Dry CFM		710-530		990-780	
	Lo-Hi Wet CFM		640-480		890-700	
Dimensions	W in		55-1/8		66-5/32	
	D in		9-1/4			
	H in		13-3/8			
Weight lbs			57		66	
OUTDOOR UNIT MODELS			PKH18FK3 / PLH18FL	PKH24FK3 / PKH24FL	PKH30FK3 / PKH30FL	PKH36FK3 / PKH36FL
External finish			Munsell 5Y 7/1			
Power supply V, Phase, Hz			208/230, 1, 60			
Max. fuse size (time delay) A			20			30
Min. ampacity A			16		20	22
Fan motor F. L. A.			0.75	0.65+0.65	0.75+0.75	
Compressor	Models		RH247NAB	NH33NBD	NH41NAD	NH47NAD
	R. L. A.		12.0	11.5	14.0	17.5
	L. R. A.		37	54	73	87
Crankcase heater A (W)			0.11/0.12 (23/28)		0.16/0.17 (33/39)	
Refrigerant control			Capillary tube			
Defrost method			Reverse cycle			
Dimensions	W in		34-1/4		38-3/16	
	D in		11-5/8		13-9/16	
	H in		33-1/2		49-9/16	
Weight lbs			131	202	245	246
REMOTE CONTROLLER			With indoor unit			
Control voltage (by built-in transformer)			Indoor unit-remote controller DC12V, Indoor unit- outdoor unit DC12V			

NOTES: *1 Rating conditions (cooling) – indoor: 80°F DB. 67°F WB outdoor: 95°F DB. 75°F WB
 (heating) – indoor: 70°F DB. 60°F WB outdoor: 47°F DB. 43°F WB
 *2 Rating conditions (heating) – indoor: 70°F DB. 60°F WB outdoor: 17°F DB. 15°F WB
 *3 Heating capacity and power consumption in [] include auxiliary electric heater operation at 208/230V.

Units should be installed by licensed electric contractor accordingly to local code requirement.

* Specifications subject to change without notice.

5. Specifications

Item	Models	PK12FK3	PK18FK3/PK18FL3	PK24FK3/PK24FL3	PK30FK3/PK30FL3	PK36FK3/PK36FL3
Cooling capacity	*1 BTU/h	12,500	18,500	24,000	30,000	34,200
Power consumption	*1 kW	1.21	1.75	2.34	3.06	3.47
SEER		11.5	11.3	10.6	10.7	10.2
INDOOR UNIT MODELS		PK12FK3	PK18FK3/PK18FL3	PK24FK3/PK24FL3	PK30FK3/PK30FL3	PK36FK3/PK36FL3
External finish		Munsell 3.4Y 7.7/0.8				
Power supply	V, Phase, Hz	115, 1, 60				
Max. fuse size (time delay)	A	15				
Min. ampacity	A	1			2	
Fan motor	F. L. A.	0.7			1.0	
Airflow	Dry CFM	490-350	710-530		990-780	
Lo-Hi	Wet CFM	440-320	640-480		890-700	
Dimensions	W	in	49-7/32		66-5/32	
	D	in	7-7/8		9-1/4	
	H	in	11-13/16		13-3/8	
Weight	lbs	37	53		62	
OUTDOOR UNIT MODELS		PU12EK	PU18EK	PU24EK	PU30EK	PU36EK
External finish		Munsell 5Y 7/1				
Power supply	V, Phase, Hz	208/230, 1, 60				
Max. fuse size (time delay)	A	15	20		30	
Min. ampacity	A	11	16		20	22
Fan motor	F. L. A.	0.65	0.75	0.65+0.65		0.75+0.75
Compressor	Model	RH167NAB	RH247NAB	NH33NBD	NH41NAD	NH47NAD
	R. L. A.	8.9	12.0	11.5	14.0	17.5
	L. R. A.	29	37	54	73	87
Crankcase heater	A (W)	0.11/0.12 (23/28)		0.16/0.17 (33/39)		
Refrigerant control		Capillary tube				
Dimensions	W	in	34-1/4			38-3/16
	D	in	11-5/8			13-9/16
	H	in	25-9/16	33-1/2	49-9/16	
Weight	lbs	105	154	207	208	220
REMOTE CONTROLLER		With indoor unit				
Control voltage (by built-in transformer)		Indoor unit-remote controller DC12V, Indoor unit- outdoor unit DC12V				

NOTES: *1 Rating conditions (cooling) – indoor: 80°F DB. 67°F WB outdoor: 95°F DB. 75°F WB

Units should be installed by licensed electric contractor accordingly to local code requirement.

* Specifications subject to change without notice.